

Pain Reliever
E3 Intense (HV-F021-EW)
E3 Intense (HV-F021-ESL)
 Instruction Manual

- Pain Reliever. Instruction Manual.
- Appareil anti-douleur. Mode d'emploi.
- Schmerztherapiegerät. Gebrauchsanweisung.
- Dispositivo per il trattamento del dolore. Manuale di istruzioni.
- Dispositivo para alivio del dolor. Manual de instrucciones.
- Apparaat ter verlichting van pijn. Gebruiksaanwijzing.
- Электронейромиостимулятор для обезболивания. Руководство по эксплуатации.
- Ağrı Giderici. Kullanım Kılavuzu.

• وحدة تخفيف الألم. دليل التعليمات.

Table of contents

Before using the unit

Introduction	3
Intended use	3
Important safety precautions and warnings	4
Know your unit	8
Package contents	8
Optional medical accessories	8
Buttons and their functions	9

Operating instructions

Assembly steps	10
STEP 1 – Insert batteries	10
STEP 2 – Attach the electrode cord to the main unit	10
STEP 3 – Snap either electrode cord to each of the pads	11
STEP 4 – Remove and discard plastic film from pads (in case of new pads)	11
STEP 5 (Optional) – Attach the unit to the belt clip	11
Get started with your therapy	12
STEP 1 – Pad placement	12
STEP 2 – Select 1 of 9 modes	15
STEP 3 – Select the correct intensity level (1 low – 15 high)	16
How to manage and reduce your pain	17
When should I start therapy?	17
How long should you use it?	17
When to stop using the unit?	17

Care and maintenance

Cleaning and storage	17
Cleaning the pads	17
When should you replace your pads?	18
Cleaning the unit	18
Storing the pads	18
Storing the unit and pads	18
Troubleshooting	19
Technical data	21
Important information regarding Electromagnetic Compatibility (EMC)	23
Warranty	24

Introduction

Thank you for purchasing OMRON E3 Intense.

In order to use the unit safely, read the complete manual carefully before using the unit for the first time.

How does it work?

E3 Intense uses Triple Action TENS (Transcutaneous Electrical Nerve Stimulation) technology that helps to:

- block the pain message
- trigger the release of endorphins (natural pain killers)
- improve the blood circulation (as result of repeated muscle contracting and relaxing)

Intended use

Medical purpose

OMRON E3 Intense is a Pain Reliever intended for reducing and relieving muscles and joints pain, stiffness and numbness in the back, arms, legs, shoulders and feet by applying electrical nerve stimulation to the surface of the skin near the site of the pain. It should be applied to normal, healthy, dry, and clean skin of adult patients.

Any of the modes can safely be used on body parts or pains described in this manual. Just find one that feels good and is comfortable on your pain. It can be successfully used in conjunction with any other pain treatment or medication.

Since the 1970s, pain relief based on TENS has been widely used by many healthcare professionals, such as physiotherapists and pain specialists.

Intended User

This unit is intended to be operated by adults who can understand this instruction manual. It is intended for home use.

Important safety precautions and warnings



It is important that you read all the warnings and precautions included in this instruction manual because they are intended to keep you safe, prevent injury and avoid a situation that could result in damage to the unit.

SAFETY SYMBOLS USED IN THIS INSTRUCTION MANUAL

⚠ DANGER	Improper use may cause danger resulting in death or serious injury. These are situations in which the device should not be used.
⚠ WARNING	Indicates a potentially hazardous situation which, if not avoided, could result in death or serious injury.
⚠ CAUTION	Indicates a potentially hazardous situation which, if not avoided, may result in minor or moderate injury to the user or patient or damage to the equipment or other property.

⚠ DANGER

Do not use this unit with these other devices:

- (1) If you have a pacemaker, implanted defibrillator, or other implanted metallic or electronic device. Such use could cause electric shock, burns, electrical interference or death.
- (2) Do not use this device while using another TENS device.
- (3) Together with a life-supporting medical electronic device such as an artificial heart or lung or respirator.
- (4) For Hospitals and Clinics, in the presence of or when attached to the body, electronic monitoring equipment (e.g. cardiac monitors, ECG alarms), which may not operate properly when the electrical stimulation device is in use.
- (5) For Hospitals and Clinics, simultaneous connection of a patient to a high frequency surgical Medical Electronic equipment may result in burns at the site of the stimulator electrodes and possible damage to the stimulator.
- (6) For Hospitals and Clinics, operation in close proximity (e.g. 1 m) to a shortwave or microwave therapy Medical Electronic equipment may produce instability to the stimulator output.



Do not use this unit under these conditions







- ⚠ Consult with your healthcare professional before using this unit. The unit may cause lethal rhythm disturbances in certain susceptible individuals. If you have had a recent surgical procedure, the stimulation may disrupt the healing process.

Do not use on these individuals

- ⚠ Pregnant women.
- ⚠ Do not use on children or infants because this device has not been evaluated for pediatric use.
- ⚠ Keep out of reach of young children because the electrode cord could cause strangulation.
- ⚠ Persons incapable of expressing their thoughts or intentions.
- ⚠ Persons incapable of operating the unit by themselves.
- ⚠ Use caution if you have a tendency to bleed internally, such as following an injury or fracture.
- ⚠ If you have suspected or diagnosed heart disease, you should follow precautions recommended by your healthcare professional.
- ⚠ If you have suspected or diagnosed epilepsy, you should follow precautions recommended by your healthcare professional.

⚠ Use caution if stimulation is applied over the menstruating uterus.

⚠ NEVER APPLY THE PADS TO THESE BODY AREAS:

	<p>The head, the mouth, or any area of the face.</p>		<p>Both sides of the thorax simultaneously (lateral or front and back), or across your chest</p>
	<p>The neck or any area of the throat because this could cause severe muscle spasms resulting in closure of the airway, difficulty in breathing, or adverse effects on heart rhythm or blood pressure.</p>		<p>because the introduction of electrical current may cause rhythm disturbances which could be lethal.</p>
	<p>Do not use near the heart, or on genital area.</p>		<p>On the calves of both legs at the same time because this may cause cardiac disturbance.</p>
			<p>On the bottom of both feet at the same time because this may cause cardiac disturbance.</p>

Open wounds or rashes or over swollen, red, infected or inflamed areas or skin eruptions (such as varicose veins, phlebitis, thrombophlebitis and thrombosis), or on top of or close to cancerous lesions, or over areas of skin that lack normal sensation.

Do not use this unit during these activities

- ⚠ When in the bath or shower;
- ⚠ While sleeping;
- ⚠ While driving, operating machinery, or during any activity in which electrical stimulation can put you at risk of injury.

Pain management warnings

- ⚠ If you have had medical or physical treatment for your pain, consult with your healthcare professional before using this unit.
- ⚠ If your pain does not improve, becomes seriously chronic or severe, or continues for more than 5 days, stop using the unit and consult with your healthcare professional.
- ⚠ The mere existence of pain functions as a very important warning telling us that something is wrong. Therefore, if you suffer from any serious illness, consult your healthcare professional in order to confirm that it is advisable for you to use this OMRON E3 Intense.

Important safety precautions and warnings

Do not alter the unit

- ⚠ Do not plug this cord into any other device that is not an OMRON E3 Intense.
- ⚠ No modification of this unit is allowed.
- ⚠ Use this unit only with the leads, electrodes, and accessories recommended by the manufacturer to avoid damage to the unit.

Warnings regarding the pads

- ⚠ Apply pads to normal, healthy, dry, and clean skin (of adult patients) because it may otherwise disrupt the healing process.
- ⚠ If you experience any skin irritation or redness after a session, do not continue stimulation in that area of the skin.

Precautions regarding the pads

- ⚠ Do not move the pads to another location while the unit is on.
- ⚠ Therapy won't work with just 1 pad. You must use 2 pads at the same time.
- ⚠ Make sure the components are connected well and the pads are fixed on the part of the body you wish to treat or the therapy may not be effective.
- ⚠ Pads should not touch any metal object, such as a belt buckle, necklace, or other metal worn under clothing.
- ⚠ Do not overlap pads or put pads on top of each other. It may weaken or stop therapy, or the unit may stop working.
Gel pads may also stick together and cause gel to be removed when separating.
- ⚠ Do not share pads with another person. This may cause a skin irritation or infection. Pads are intended for use by one person.
- ⚠ Do not leave pads attached to the skin after treatment.
- ⚠ Do not bend or fold because the gel may get damaged and it won't stick or function properly.
- ⚠ To avoid damage to the adhesive surface of the pads, put the pads only on the skin or on the plastic pad holder provided to avoid damage to the adhesive surface of the pads.
- ⚠ Always place clean pads in accordance with illustrations provided (Refer to pages 12-14, Pad Placement).
- ⚠ Do not apply ointment or any solvent to the pads or to your skin because it will disrupt the pads from functioning properly. The self-adhesive pads will adhere to your skin.
- ⚠ Place pads at least 3 cm apart for optimal results.

Caution while using the unit

Main unit

- ⚠ If the unit is not functioning properly or you feel discomfort, immediately stop using the unit.
- ⚠ Do not use for any other purpose except for what it is intended for.
- ⚠ Do not place in a room with high humidity, such as a bathroom. This will damage the unit. Ideal temperature for using +10 - +40 °C, 30 - 80 % relative humidity.
- ⚠ Do not use the unit without proper lighting. You may not be able to operate the unit successfully.
- ⚠ While using this device, make sure that no mobile phone or any other electrical devices that emit electromagnetic fields is within 30cm. This may result in degradation of performance of the device.

Cord

- ⚠ Do not insert the electrode plug into any place other than the jack on the unit.
- ⚠ Do not pull on the electrode cord during treatment. Do not bend or pull the end of the cord.
- ⚠ When pulling out the cord from the unit, hold the plug and pull.
- ⚠ Replace the cord when broken or damaged.

Battery

- ⚠ Do not throw the batteries into a fire. The batteries may explode.
- ⚠ Dispose of the unit, batteries, and components according to applicable legal regulations. Unlawful disposal may cause environmental pollution.
- ⚠ Do not mix alkaline and manganese batteries as this will shorten the battery life.
- ⚠ During therapy, do not remove the battery cover and do not touch the battery terminals.
- ⚠ Use the battery within recommended period mentioned to it.

Pads

- ⚠ Detach the pads before replacing the batteries.

General precautions

- ⚠ The long-term effects of electrical stimulation are unknown.
- ⚠ Apply stimulation to only normal, intact, clean, dry, and healthy skin.
- ⚠ TENS is not effective in treating the original source or cause of the pain, including headache.
- ⚠ TENS is not a substitute for pain medications and other pain management therapies.
- ⚠ TENS devices do not cure disease or injuries.
- ⚠ TENS is a symptomatic treatment and, as such, suppresses the sensation of pain that would otherwise serve as a protective mechanism.
- ⚠ You may experience skin irritation or hypersensitivity due to the electrical stimulation or electrical conductive medium (gel).
- ⚠ Keep the unit away from young children. The unit contains small pieces that may be swallowed. Immediately contact your healthcare professional.

Possible adverse reactions

- ⚠ You should stop using the unit and consult with your healthcare professional if you experience adverse reactions from the unit.
- ⚠ You may experience skin irritation beneath the stimulation electrodes applied to your skin.
- ⚠ Do not use to treat one region for extended periods of time (more than 2 × 15 minutes a session, up to 3 times/day) or muscles in that region may become exhausted and sore.

Know your unit

Package contents

Main unit



Electrode cord



Pad holder



Long Life Pads

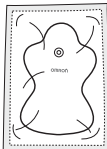

Batteries for trial use



Belt clip



Soft pouch



Instruction manual



Optional medical accessories

- Long Life Pads (HV-LLPAD-E)

Buttons and their functions

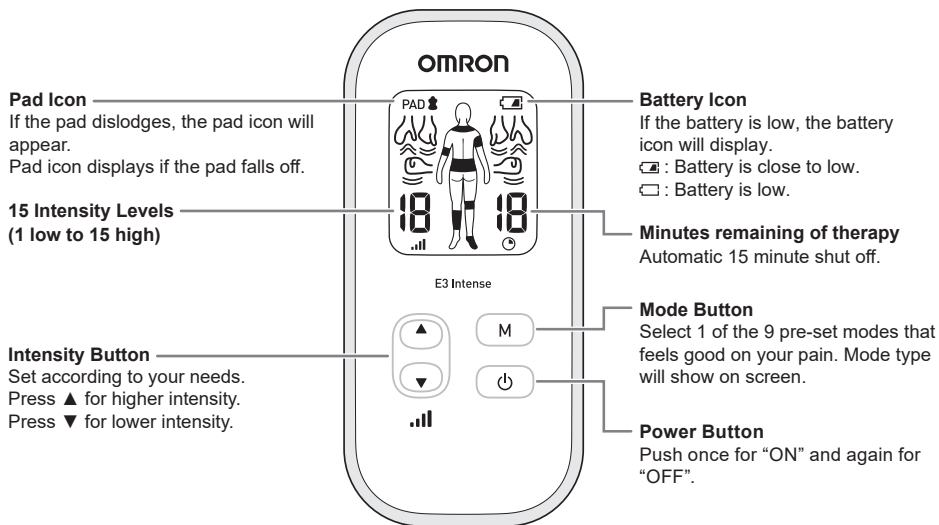

Assembly steps

Before using, check these points to make sure everything is working properly.

1. The cord is not broken.
2. The pad adhesive sticks and is not damaged.
3. The electrode cord connection is not broken.
4. The unit is intact and in working order.
5. There is no battery leakage.

STEP 1 – Insert batteries

1. Remove the battery cover on the back using a coin.

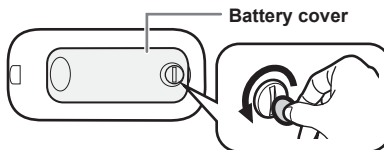

2. Insert batteries. Make sure the \oplus \ominus signs correspond when inserting batteries.

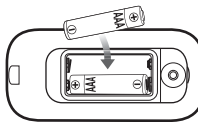

3. Reinstall the battery cover. Tighten with a coin.

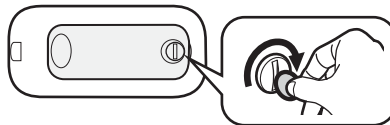

STEP 2 – Attach the electrode cord to the main unit

Attach the electrode cord plug to the bottom of the main unit.

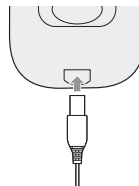

STEP 3 – Snap either electrode cord to each of the pads

For the first time, take the pads out of the sealed package.

- ⚠ Do not turn the unit on, until pads are on your skin.
- ⚠ You must use both pads or stimulation will not work.

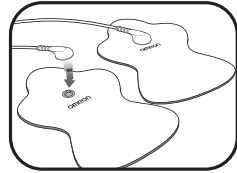

STEP 4 – Remove and discard plastic film from pads (in case of new pads)

Remove the clear plastic film from the back of the pad.

Discard the plastic film backing as well as the clear packaging.

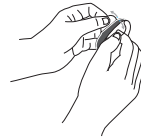

STORING PADS ON PAD HOLDER

After using, put sticky side of pads on either side of the pad holder.

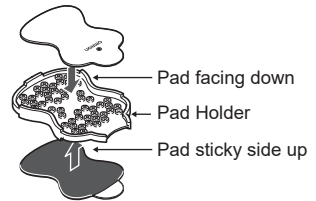

EN

STEP 5 (Optional) – Attach the unit to the belt clip

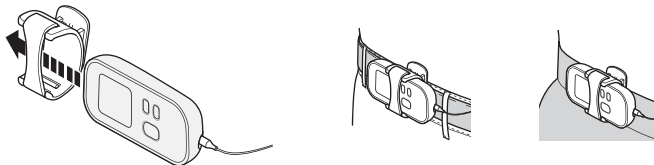

- ⚠ The clip may fall off if attached to soft or thin clothing.

Get started with your therapy

(Use for a maximum of 2 x 15 minutes per session)

STEP 1 – Pad placement

For optimal therapy:

- ⚠ Place pads on either side of the pain, not directly on the pain.
- ⚠ Place 2 pads at least 3 cm apart.
- ⚠ Do not overlap pads or put on top of each other.
- ⚠ Do not add spray, lotions or creams to skin or pads.
- ⚠ Do not share pads.

Before starting your therapy, rate your pain from 1 low to 15 high. This mental check gives you a basis you can compare to once the session is complete.

Examples of pads application

LOWER BACK

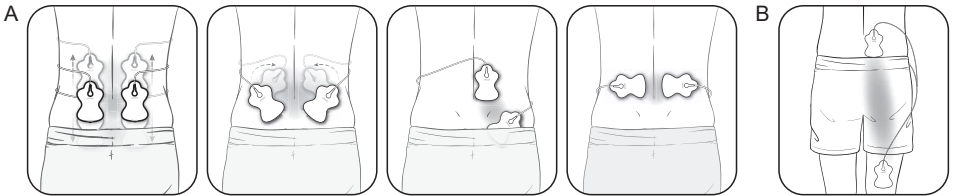

- A. Attach both pads on the lower back according to your pain.
Place pads on muscle of back, not on spine, for optimal therapy.
- B. Attach 1 pad below and above the region in pain, both on same side.

ARM

Attach both pads on either side of the area with pain.

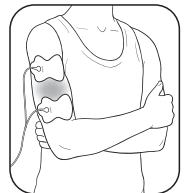

JOINT (ELBOW)

Attach both pads on either side of the joint with pain.

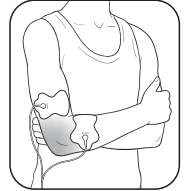

JOINT (KNEE)

Attach both pads above the knee or above and below the joint with pain.

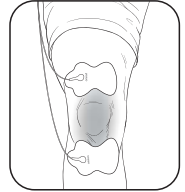
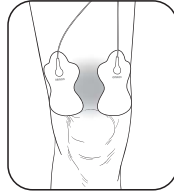

LEG (HIP & THIGH)

Attach both pads on either side of the area with pain.

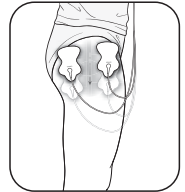

EN

LEG (CALF)

Attach both pads on the calf with pain.

⚠ Pads should not be placed simultaneously on the calves of both legs.

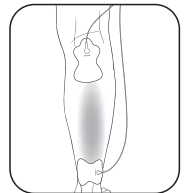
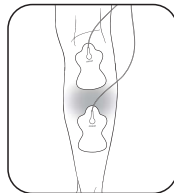

(continued)

STEP 1 – Pad placement (continued)

FOOT (ANKLE)

Attach the pads on the left for pain on the outside of your ankle/foot. Attach the pads on the right for pain on the inside of your ankle/foot.

⚠ **Do not put the pads on the bottom of both feet at the same time.**



Outside

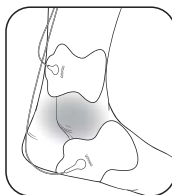

Inside

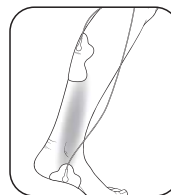

SHOULDER

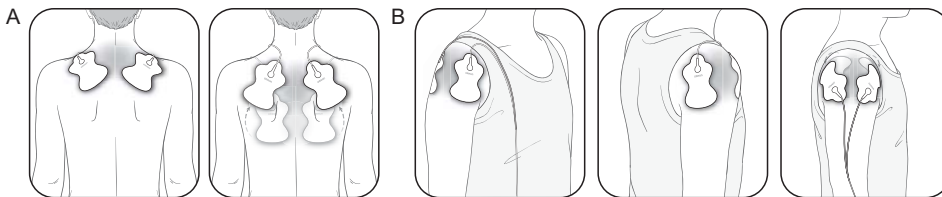

A. Attach both pads on the shoulder according to your pain.

B. Attach 1 pad on the front and on the back of your shoulder.

⚠ **Do not use near the heart, on both sides of the thorax or across your chest because the introduction of electrical current may cause rhythm disturbances which could be lethal.**



STEP 2 – Select 1 of 9 modes

- Push “⏻”.
- Choose 1 of the 9 modes. Modes cannot be combined.

Choose a massage-like mode

1. Tapping
2. Kneading
3. Rubbing

Or choose a pain mode:

4. Arm
5. Lower Back
6. Leg
7. Foot
8. Joint (Knee/elbow/wrist)
9. Shoulder

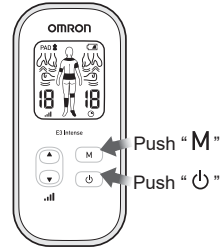

How to switch modes

The unit automatically defaults to the last mode selected. Each time you push the mode button (“M”), it switches to the next mode at the lowest intensity. You can only use ONE MODE at a time.

How to select the right mode

Any of the modes can be used on body parts or pains described in this manual.

Select the mode that feels right for your unique pain.

Arm



Lower back



Leg



Foot



EN

Therapies designed for	Arm	Lower back	Leg	Foot
Potential conditions	Swelling, stiffness, sore or achy, muscle or nerve pain.	Stiffness, soreness, muscle or nerve pain.	Swelling, fatigue, stiffness, muscle or nerve pain.	Swelling, fatigue, chilly feeling, sore or achy.
Sensation	Series of low to medium rate tapping, tingling and pulsing sensations.	Series of high rate to low tingling sensations, followed by tapping. With higher intensity, you may feel kneading or massage-like sensations.	Series of low to medium tapping and rubbing sensations.	Series of low rate tapping, pulsing sensations.

(continued)

STEP 2 – Select 1 of 9 modes (continued)

Joint



Shoulder



Tap



Knead



Rub



Therapies designed for	Joint	Shoulder	Tap	Knead	Rub
Potential conditions	Swelling, stiffness, sore or achy.	Stiffness, sore or achy, tight feeling.	Stiffness, soreness, tight feeling.	Stiffness, sore or achy, knotty muscles, tight feeling.	Stiffness, sore or achy, knotty muscles, tight feeling.
Sensation	Series of medium to high rate tapping, pulsing sensations.	Series of low to high rate tapping, pulsing, kneading and massage-like sensations.	Series of low rate tapping sensations.	Series of medium rate pulsing sensations to mimic massage.	Series of high rate pulsing sensations to mimic hands rubbing.

STEP 3 – Select the correct intensity level (1 low – 15 high)

Start at the lowest intensity level and slowly increase it by pushing the “▲(Up)” arrow button. You should feel a gentle pulsing sensation.

How do I pick the right intensity level for my pain?

Each time you push “▲(Up)” or “▼(Down)” arrow, it moves to another level. If the stimulation sensation becomes weaker or disappears, increase the intensity until it is restored. But, if the sensation is at all uncomfortable, press the down arrow to decrease the intensity.

- Press ▲ for higher intensity.
- Press ▼ for lower intensity.

How long is the therapy?

The unit will continue automatically for 15 minutes before it shuts off. We recommend a total of 2 × 15 minutes therapy in one sitting, up to 3 times/day. The screen shows you how many minutes are remaining.

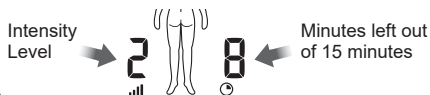

How to manage and reduce your pain

When should I start therapy?

Use as soon as your pain begins. Start with one session (the unit automatically turns off at 15 minutes). Turn off with pads still on and rate your pain again.

How long should you use it?

Start with one 15 minute session. Always turn the unit off with pads still on. Rate your pain to check your progress. Stop therapy session if pain has reduced or stopped. Press “⏸” button to continue therapy for another 15 minute session.

1 session 15 minute automatic shut-off	Max minutes/session 2 x 15 minutes	Max times/day 3 times per day
---	---	--

⚠ See warnings on page 7. Long-time treatment and strong stimulation may cause muscular fatigue and may generate adverse effects.

When to stop using the unit?

1. If you experienced an adverse reaction (skin irritation/redness/burns, headache or other painful sensation, or if you feel any unusual discomfort).
2. If your pain does not improve, becomes seriously chronic and severe, or continues for more than 5 days.

Cleaning and storage

The unit is designed for repeated use over time. The pads will last up to 150 uses, or 5 months (based on use 1/day). Here are important cleaning and storage instructions:

Cleaning the pads

1. Turn the power off and remove the electrode cord from the pads.
2. Wash the pads when the adhesive surface becomes dirty and/or the pads are difficult to attach.
 - Wash the pad softly with your fingertips under slow running cold water for several seconds (do not use a sponge/cloth/ sharp object like a nail on the adhesive side, do not use detergents, chemicals or soap).

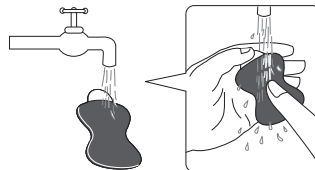

3. Pads can be washed after 15 uses, approximately 10 times for up to 150 uses. Do not wash the pads too long or too frequently. If the adhesive surface becomes sticky or the pad peels off, leave the pad in the refrigerator (do not freeze) overnight. The adhesion may be restored.
4. Dry the pads and let the adhesive surface air-dry completely. Do not wipe with a tissue paper or cloth.
5. Pads are replaceable and can be purchased.

Cleaning and storage

The life of the pads may vary by how often you wash the pads, the skin condition, and how you store the pads.

When should you replace your pads?

If the pad no longer sticks to your skin or if more than 25 % of the pad's surface is not in contact with your skin.

Cleaning the unit

1. Turn the unit off and disconnect the electrode cord from the pads.
2. Clean with a cloth lightly moistened or soaked in a neutral (mild) cleaning solution and wipe gently.
 - Do not use chemicals (like thinner, benzene).
 - Do not let water get into the internal area.

Storing the pads

1. Turn the unit off and remove the cord from the bottom of the unit.
2. Remove the pads from your body.
3. Leave the electrode cord connected to the pads.

Place the pads on the pad holder, 1 pad on each side with the sticky side of each pad on the pad holder.

4. Wrap the electrode cord around the pad holder.

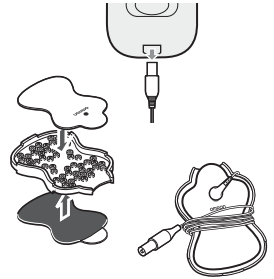

Storing the unit and pads

- Store the unit with the belt clip on.
Store the pads with the electrode cord on the pad holder and put into the pouch.
- Do not keep in areas subject to direct sunlight, high or low temperatures, humid area, near to fire, vibration, or shock.
- Do not keep at places that can be easily reached by children.
- When not in use for a long period, remove the batteries before storage, to avoid liquid discharge from batteries.
- Do not wrap the electrode cord around the unit because it may damage the cord.

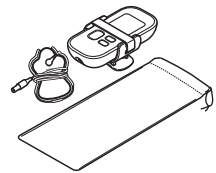

Troubleshooting

In case of any of the below problems occurs during use, first check that no other electrical device is within 30cm. If the problem persists, refer to the table below.

If this happens...	Possible causes...	Try this solution...
The intensity is not felt. Very weak intensity level.	Are you using only 1 pad?	Put the other pad on your skin. You must use both pads for therapy to work.
	Have you removed the transparent film from the pads?	Peel off the film on the adhesive surface of pads.
	Are the pads stacked together or do pads overlap?	Check placement of pads. Refer to pages 12-14, Pad Placement.
	Is the cord properly connected to the unit?	Connect the cord plug correctly into the jack at the bottom of this unit.
	Is the intensity setting too low?	Press the ▲ up button.
	Is the gel damaged?	Replace the pads.
	Are the batteries weak?	Replace both batteries.
The skin turns red or feels irritated.	Is the adhesive surface of pads dirty or dry?	Wash the adhesive surface of pads softly with your fingertips for about 3 seconds under cold slow running water.
	Is therapy time too long?	Use less than 15 minutes.
	Are the 2 pads attached properly to the body?	Refer to pages 12-14, Pad Placement and attach correctly.
	Is the pad surface worn out?	Replace both pads at the same time.
No power source.	Are the polarities of battery (+ and -) aligned in the wrong direction? Are the batteries depleted?	Check the batteries for correct alignment. Replace the batteries.
Power cut off during use.	Are the batteries weak?	Replace both batteries at the same time.
	Is the cord broken?	Replace the cord.
Battery icon is empty or close to empty. 	Are the batteries weak?	Replace both batteries at the same time.
Pad gel does not stick to skin.	Is the adhesive surface of pads dirty or dry?	Wash the adhesive surface of pads softly with your fingertips for about 3 seconds under cold slow running water.
	Have you removed the transparent film from the pads?	Peel off the film on the adhesive surface of pads.
	Is the pads wet? or Is your skin too wet?	Air dry the pads. Or dry the skin.
	The pad gel may be damaged.	Replace the pads.
	Are you using the pads during perspiring?	Dry the pad placement area.
	Have the pads been washed too long and/ or too frequently?	Leave the pads in refrigerator (do not freeze) for overnight.
	Were the pads stored under high temperature, high humidity, or direct sunshine?	Replace the both pads.

If this happens...	Possible causes...	Try this solution...
Pad icon is displayed. PAD 	Only 1 pad is attached, or both pads are not attached.	Re-attach dislocated pad(s) onto the skin firmly. Power off-on after correction.
	Have you removed the transparent film from the pad?	Peel off the film on the adhesive surface of pads. Power off-on after correction.
	Is the cord properly connected to the main unit?	Connect the cord plug correctly into the jack at the bottom of the main unit. Power off-on after correction.
	Is the adhesive surface of pads dirty or dry?	Wash the adhesive surface of pads softly with your fingertips for about 3 seconds under cold slow running water. Power off-on after correction.

Technical data



















Product Category	Electroanalgesic Transcutaneous Stimulator
Product Description	Pain Reliever
Model (code)	E3 Intense (HV-F021-EW) E3 Intense (HV-F021-ESL)
Operation Mode	Continuous operation
Power Source	DC3 V (2 AAA alkaline batteries or 2 AAA manganese batteries)
Battery Life	New batteries (2 AAA alkaline batteries) will last for approx. 4 months (when used for 15 minutes a day, Lower Back Mode, max. intensity).
Frequency	Approx. 1 to 238 Hz
PULSE Duration	150 µsec
Maximum Output Voltage	70 V (during 500 Ω load)
Power Control	15 intensity levels
Operating Temperature, Humidity and Air Pressure	+10 to +40 °C / 30 to 80 % RH (non-condensing) / 700 to 1060 hPa
Storage and Transportation Temperature, Humidity, Air Pressure	-20 to +60 °C / 10 to 95 % RH (non-condensing) / 700 to 1060 hPa
Weight	Approx. 100 g (incl. batteries)
Outer Dimensions	52 (W) × 112 (H) × 25 (D) mm
Package Contents	Main unit, Electrode cord, Pad holder, Long Life Pads, Batteries for trial use, Belt clip, Soft pouch, Instruction manual
Classifications	Internally powered (Protection against electric shock) Type BF (Applied part; Pads) IP22 (Ingress Protection)

EN

This OMRON product is produced under the strict quality system of OMRON HEALTHCARE Co., Ltd., Japan.

Designed for a minimum of 5 years life expectancy.

Description of symbols that, depending on a model, can be found on the product itself, product sales package or IM

	This product should not be used by persons with medical implants, e.g. heart pacemakers, artificial heart, lung or other electronic life support systems.		
	Applied part - Type BF Degree of protection against electric shock (leakage current)		
IP XX	Ingress protection degree provided by IEC 60529		For indoor use only
	Serial number		Symbol of Eurasian Conformity
	Indication of connector polarity		Need for the user to consult the instructions for use
	CE Marking		Class II equipment
	GOST-R symbol		Temperature limitation
	Humidity limitation		Atmospheric pressure limitation
	Direct current		Alternating current
	Date of manufacture		Medical device
	Technology by OMRON Healthcare in Japan		

CE 0197

NOTE:

- These specifications are subject to change without notice.
- IP classification is degrees of protection provided by enclosures in accordance with IEC 60529. The device is protected against solid foreign objects of 12.5 mm diameter and greater such as a finger, and against oblique falling water drops which may cause issues during a normal operation.
- Please report to the manufacturer and the competent authority of the Member State in which you are established about any serious incident that has occurred in relation to this device.

Important information regarding Electromagnetic Compatibility (EMC)

HV-F021-EW and HV-F021-ESL manufactured by OMRON HEALTHCARE Co., Ltd. conform to EN60601-1-2:2015 Electromagnetic Compatibility (EMC) standard. Further documentation in accordance with this EMC standard is available at OMRON HEALTHCARE EUROPE at the address mentioned in this instruction manual or at www.omron-healthcare.com. Refer to the EMC information for HV-F021-EW and HV-F021-ESL on the website www.omron-healthcare.com and Warranty card in the package if purchasing in Russia.



Correct Disposal of This Product (Waste Electrical & Electronic Equipment)

This marking shown on the product or its literature, indicates that it should not be disposed of, with other household wastes at the end of its working life. To prevent possible harm to the environment or human health from uncontrolled waste disposal, please separate this product from other types of wastes and recycle it responsibly to promote the sustainable reuse of material resources.

Household users should contact either the retailer where they purchased this product, or their local government office, for details of where and how they can return this item for environmentally safe recycling.

Business users should contact their supplier and check the terms and conditions of the purchase contract. This product should not be mixed with other commercial waste for disposal.

Warranty

Thank you for buying an OMRON product. This product is constructed of high quality materials and great care has been taken in its manufacturing. It is designed to give you a high level of comfort, provided that it is properly operated and maintained as described in the instruction manual.

This product is warranted by OMRON for a period of 3 years after the date of purchase. The proper construction, workmanship and materials of this product is warranted by OMRON. During this period of warranty OMRON will, without charge for labour or parts, repair or replace the defect product or any defective parts.

The warranty covers only products purchased in Europe, Russia and other CIS countries, Middle East and Africa.

The warranty does not cover any of the following:

- a. Transport costs and risks of transport.
- b. Costs for repairs and / or defects resulting from repairs done by unauthorised persons.
- c. Periodic check-ups and maintenance.
- d. Failure or wear of accessories or other attachments other than the main device itself, unless explicitly warranted above.
- e. Costs arising due to non-acceptance of a claim (those will be charged for).
- f. Damages of any kind including personal caused accidentally or from misuse.

Should warranty service be required please apply to the dealer whom the product was purchased from or an authorised OMRON distributor. For the address refer to the product packaging / literature or to your specialised retailer. If you have difficulties in finding OMRON customer services, visit our website (www.omron-healthcare.com) for contact information.

Repair or replacement under the warranty does not give rise to any extension or renewal of the warranty period.

The warranty will be granted only if the complete product is returned together with the original invoice / cashticket issued to the consumer by the retailer. OMRON reserves the right to refuse the warranty service if any unclear information has been given.

<p>Manufacturer Fabricant Hersteller Produttore Fabricante Fabrikant Производитель Üretici الشركة المصنعة</p> 	<p>OMRON HEALTHCARE Co., Ltd. 53, Kunotsubo, Terado-cho, Muko, KYOTO, 617-0002 JAPAN</p>		
<p>EU-representative Mandataire dans l'UE EU-Repräsentant Rappresentante per l'UE Representante en la UE Vertegenwoordiging in de EU Представитель в ЕС AB temsilcisi جهة التمثيل بالاتحاد الأوروبي</p> <table border="1" data-bbox="87 524 217 578"> <tr> <td>EC</td> <td>REP</td> </tr> </table> <p>Importer in EU Importador en la UE Importateur dans l'UE Importeur in de EU Importeur in der EU Импортер в ЕС Importatore per l'UE AB'deki İthalatçı المستورد في الاتحاد الأوروبي</p>	EC	REP	<p>OMRON HEALTHCARE EUROPE B.V. Scorpius 33, 2132 LR Hoofddorp, THE NETHERLANDS www.omron-healthcare.com</p>
EC	REP		
<p>Production facility Site de production Produktionsstätte Stabilimento di produzione Planta de producción Productiefaciliteit Производственное подразделение Üretim Tesisi منشأة التصنيع</p>	<p>OMRON DALIAN Co., Ltd. No. 3, Song Jiang Road, Economic and Technical Development Zone, Dalian 116600, China</p>		
<p>Subsidiaries Succursales Niederlassungen Consociate Empresas filiales Dochterunternehmen Филиалы Yan Kuruluşlar الشركات التابعة</p>	<p>OMRON HEALTHCARE UK LTD. Opal Drive, Fox Milne, Milton Keynes, MK15 0DG, UK www.omron-healthcare.com</p> <p>OMRON MEDIZINTECHNIK HANDELSGESELLSCHAFT mbH Konrad-Zuse-Ring 28, 68163 Mannheim, GERMANY www.omron-healthcare.com</p> <p>OMRON SANTÉ FRANCE SAS 3, Parvis de la Gare, 94130 Nogent-sur-Marne, FRANCE Uniquement pour le marché français: OMRON Service Après Vente N° Vert 0 800 91 43 14 www.omron-healthcare.com</p>		

Issue Date / Fecha de publicación/
Date of publication / Uitgiftedatum /
Ausgabedatum / Дата выпуска / : 2020-04-10
Data di pubblicazione / Yayın Tarihi /
تاريخ الإصدار

Made in China
Fabriqué en Chine
Hergestellt in China
Prodotto in Cina

Fabricado en China
Geproduceerd in China
Сделано в Китае
Çin'de Üretilmiştir
صنع في الصين