

Installation and User Instructions

RSP CONIC



MADE IN SPAIN

Inercial Performance S.L.
www.einercial.com

Table of Contents

Introduction.....	3
Components.....	3
Installation.....	4-6
Adjusting The Handle Position.....	7-8
Adding Weights to the Flywheel.....	8-9
How to move the rail.....	9
Different angles to pull the rope.....	10
Technical Specifications.....	10
Accessories.....	11
Use.....	11
Maintenance.....	11
Replacing the Rope.....	12-13
Warranty.....	13

INTRODUCTION

The main characteristic of the Conical Pulley, due to the cone's nature, is that the movement is accelerated with progressive weight. The rope's radius decreases as it moves across the cone, progressively increasing resistance. The nature of the weight is inertial, that is, depending on how much power the user applies to the machine, power values will be higher or lower. This feature wide range of use of the subject, since we always work on percentages of individual power of the user. We can practise a great variety of exercises, making it possible to train every muscle group from a single machine by attaching different accessories to the end of the rope. Moreover, this machine's weight range is really wide.

We increase weight by working over the free cone radius with a roll-up rope, and also by shifting the inertia moment using 4 integrated masses on the disk (they can be extracted).

The wider the radius, the lighter the weight; and the narrower the radius, the heavier the weight. This regulation is performed through a lengthwise rail along the cone.

The moment of inertia is adjusted through the different masses integrated within the disk. There are three possible positions.

COMPONENTS

4 . Masses of aluminium (10 % moment of inertia every mass).

1. Longitudinal rail with Block (to fit \varnothing of the cone).

1. Block wall outlet.

1. grip hand and ankle.

4. m rope (Dyneema 4 mm).

4 . screws and 1 ring (to fix the machine to the wall).

1. 120 cm high rail (to adjust the output block)

1. installation manual.

INSTALATION

Parts of the machine.

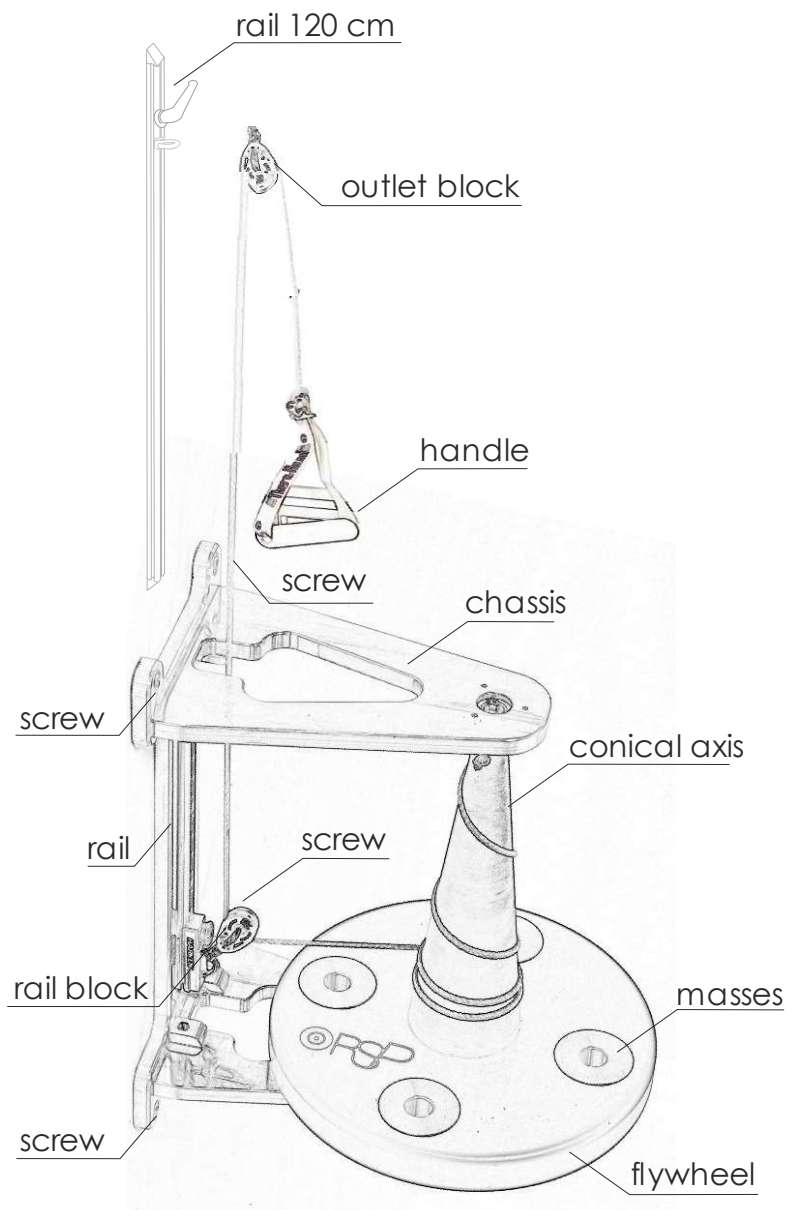

Place de Machine.

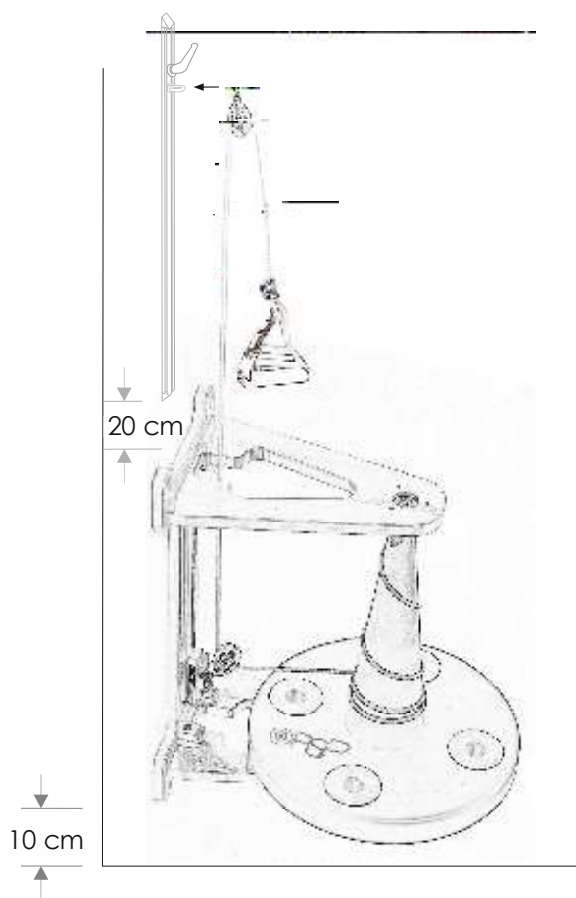

The surface where the machine is placed must be installed on a stable and level base.
Place de machine as close as possible to the ground, if you have baseboards will be placed above it.

The rail of 120 cm is placed centered with the machine and 20 cm of it.

Set the machine to the wall

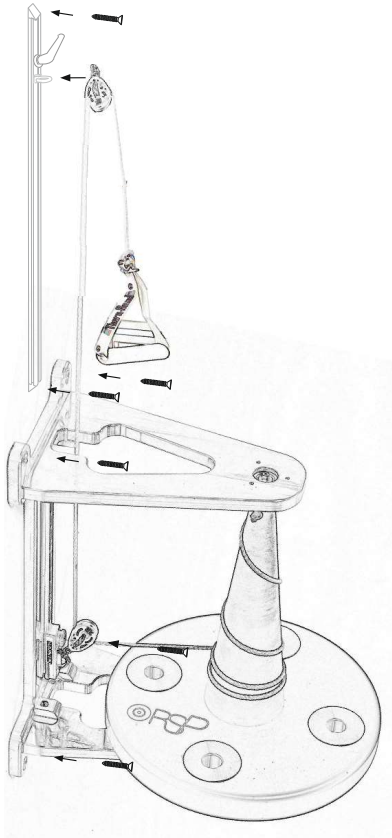

x6



x1 output ground.*



x6



x1 output ground.*

8 mm Ø

10 mm Ø



x1

* This ringbolt mounting (optional) is used to derive the output block to the ground.

Make four holes in the wall to the height indicated, first insert the plugs and screw the four screws into the wall. Then install the rail to the block of wall outlet to the height indicated, with the plugs and screws indicated.

ADJUSTING THE HANDLE POSITION





FLYWHEEL MASS

The mass of the flywheel defines a large range of speed/force curves that can be varied

MASS (Flywheel weight) CHANGE INSTRUCTIONS



Press the bottom up to
remove the masses



without mass

How to place the masses



Place the mass right

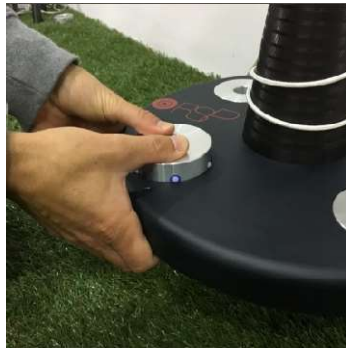

Press up and down



Until it is in line with the flywheel

The RSP conic flywheel comes with four masses to modify the force/speed parameters.

The flywheel has four locations to add or delete steel weights in opposite pairs.

Placement masses:

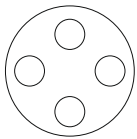

without masses

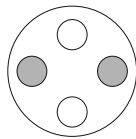

2 masses

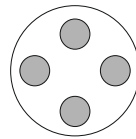

4 masses

IMPORTANT: FLYWHEEL WEIGHTS MUST BE ADDED OR DELETED IN PAIRS AND IN DIRECTLY OPPOSITE LOCATIONS

HOW TO MOVE THE RAIL



The marked workpiece

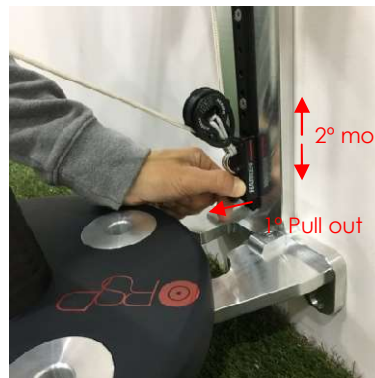

Pull out and move up or down

2° move up or down

1° Pull out

DIFFERENT ANGLES TO PULL THE ROPE



Wall outlet block.



Output pulley from the ground.



Output of the cone.

TECHNICAL SPECIFICATIONS

Developed for the work of all the muscular groups.

CAD-CAM Technology, numerical control manufactured machine.

Made from aluminum.

Rope without coefficient of elasticity.

Exact control of cone-disk-axis moment of inertia.

Low-friction bearings and high quality pulleys.

Weight adjustment on the cone radius, 13 weight positions.

Moment of inertia adjustment through disk integrated masses, 3 inertia moments (0 masses, 2 masses, 4 masses).

We eliminate interference resulting from vibration and friction.

2 rope output options: high and low.

Size: 45 x 35 x 45 cm high

Weight: 11 kg

Deliver: Comes with hand grip, ankle strap, head pulley, 4 m of rope, high head pulley, 120 cm rail and 4 aluminum masses.

Adaptations: Customization for specific trainings Inertial performance, S.L., with CIF B 27813518 declares that this training equipment is in accordance with the norm EN 957-2, Class S.

Moments of inertia.

without masses	2 masses	4 masses	2 masas inox +60%	4 masas inox +120%	2 masas inox/2 alum +80 %
531,39 Kg/cm ²	635,13 kg/cm ²	738,86 Kg/cm ²	829,37 Kg/cm ²	1126,22 kg/cm ²	933,11 Kg/cm ²

ACCESORIES

Encoder RSP compatible with Smartcoach.

Chronojump adapter.

Traction bars of carbon fiber.

Inox masses (increase 29 % the moment of inertia)

Portability kit to attach the machine to goal structures, columns, gym bars...

Spare parts: <http://einerical.com/en/shop/>

USE

Rope always tense.

Always work with the rope coiled in the axis to avoid to squash the bearings of the blocks.

It's important to do the exercises with a suitable technique and must be supervised by a professional. You can affect the health an excessive or incorrect use of the machine, please consult your doctor before exercising.

It is important to keep the unattended children away from the machine.

The blocks and the ropes are elements of wear by the use of the machine.

RSP recommends the use of his blocks and ropes to guarantee the ideal functioning of the machines.

RSP is not responsible for wear caused by misuse of the machine.

Maximum weight of user 100 kg.

To know the whole gallery of exercises and the safe and proper use of the machine visit:

<http://einerical.com/en/tutorials/>

MAINTENANCE

Clean the machine with a damp cloth without using any abrasive product.

Do not leave machine in very humid places. Indoor use.

Replace the rope if it is worn or broken, the blocks and the ropes are elements of wear by the use of the machine.

Spare parts: <http://einerical.com/en/shop/>

Call for assistance if required. +34 659910685

REPLACING THE ROPE



Delete the previous Rope



Materials needed for change

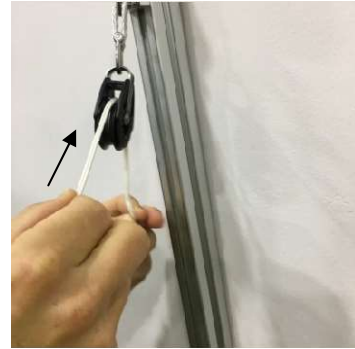

Put one end of the rope through the wall outlet block.





WARRANTY

1. Inercial Performance, S.L. warrants to the purchaser that RSP conic is free of defects in materials and workmanship under normal use and maintenance, has a limited warranty of 2 years from the date of purchase, subject to the terms and conditions that marks the Spanish law, after 6 months of this period the costumer will have to prove that the fault exists since the origin of the purchase
2. This warranty does not cover any damage caused by handling, misuse, tampering, negligence, accidents, abnormal conditions, lack of adequate maintenance or unauthorized service or alterations to the product.
3. The blocks and the ropes are elements of wear by the use of the machine, are not subject to this warranty except for manufacturing defect.
4. In the event that the machine is damaged from the factory in the first 6 months after the purchase (point 1) will replace the defective part or be replaced the machine, if necessary, without any cost for our client.



RSP CONIC is manufactured in Spain.
www.einercial.com

Inercial Performance S.L.
Avd. Val Miñor, 46 1ºC
36350 Nigrán (Pontevedra)
Telf + 34 659910685
Spain